

Description

The HTN7G21S040P(G) is an unmatched discrete LDMOS Power Amplifier with 60W saturated output power covering frequency range from 700 - 2100 MHz.

Features

- Operating Frequency Range: 700 - 2100 MHz
- Operating Drain Voltage: +28V
- Saturation Output Power: 40W
- Power Average: 3.98W
- Excellent thermal stability due to low thermal resistance package
- Enhanced robustness design without device degradation
- Internally integrated enhanced ESD design

Applications

- CDMA
- W-CDMA
- GSM EDGE
- MC-GSM
- TDD/FDD LTE
- WiMAX

Ordering Information

Part Number	Description
HTN7G21S040P(G)	Reel Package
HTN7G21S040P(G)EVB1	920-960 MHz EVB
HTN7G21S040P(G)EVB2	1800-1880 MHz EVB

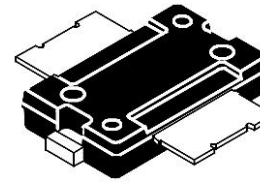

TO-270



Over-Molded 2 leads (Straight)
HTN7G21S040P

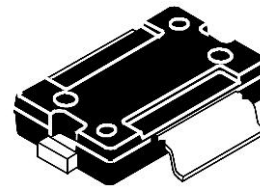

TO-270-A



Over-Molded 2 leads (Gull Wing)
HTN7G21S040P(G)

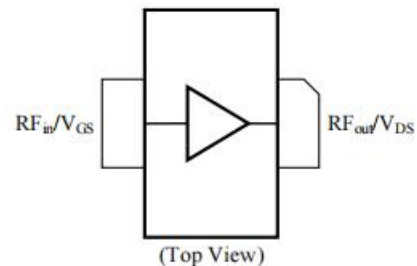

Note: Exposed backside of the package is the source terminal for the transistor

Pin Connections



HTN7G21S040P(G)

40W, 700 - 2100 MHz LDMOS Amplifier

Product datasheet

Typical Performance

RF Characteristics (Pulsed CW)

Freq (MHz)	Gain (dB)	P1dB (dBm)	Eff(%)@P1dB	P3dB (dBm)	Eff(%)@P3dB
920	21.4	47.5	61.2	48.5	66.2
940	21.4	47.4	63.1	48.3	68.3
960	21.4	47.0	64..1	48.0	69.8

Freq (MHz)	Gain (dB)	P1dB (dBm)	Eff(%)@P1dB	P3dB (dBm)	Eff(%)@P3dB
1800	15.5	46.3	47.4	47.6	52.3
1840	16.2	46.1	50.9	47.2	54.8
1880	16.0	45.6	52.7	46.5	56.4

Test conditions unless otherwise noted: 25 °C, VDD = +28Vdc, IDQ=360mA, PW = 100us, DC= 10% test on WATECH Application Board

RF Characteristics (WCDMA)

Freq (MHz)	Gain (dB)	Eff (%)	ACPR_L* @5MHz (dBc)	IRL (dB)
920	21.5	16.9	-45.0	7
940	22.0	17.6	-45.9	8.4
960	21.7	18.5	-47.6	7.1

Freq (MHz)	Gain (dB)	Eff (%)	ACPR_L* @5MHz (dBc)	IRL (dB)
1800	15.4	15.4	-48	8
1840	16.1	16.5	-47	10
1880	15.9	17.6	-45	7

Test conditions unless otherwise noted: 25 °C, VDD = +28Vdc, IDQ= 360mA, PAVG = 36 dBm (3.98W), 1C-WCDMA 5MHz Signal, 9.9 dB PAR @ 0.01% CCDF test on WATECH Application Board

*Uncorrected DPD

Absolute Maximum Ratings

Parameter	Range/Value	Unit
Drain voltage (V _{DSS})	-0.5, +65	V
Gate voltage (V _{GS})	-5 to +10	V
Operation voltage (V _{DD})	+0 to +28	V
Storage Temperature (T _{STG})	-55 to +150	°C
Case Temperature (T _c)	-40 to +150	°C
Junction Temperature (T _J)	-40 to +225	°C

Electrical Specification

DC Characteristics

Parameter	Conditions	Min	Typ	Max	Unit
Breakdown Voltage V _{(BR)DSS}	V _{gs} =0V, I _{ds} =48uA	65	-	-	V
Gate-Source Threshold Voltage V _{GS(th)}	V _{ds} =V _{gs} , I _{ds} =48uA	0.8	1.3	1.8	V
Drain Leakage Current I _{DSS}	V _{gs} =0V, V _{ds} =65V	-	-	10	uA
Gate Leakage Current I _{GSS}	V _{gs} =5V, V _{ds} =0V	-	-	1	uA

Load Mismatch Test

Condition	Test Result
VSWR=10:1, at all Phase Angles, VDD = +28Vdc, IDQ= 360mA, CW signal 47dBm (50.1W) @1840 MHz test on WATECH Application Board	No Device Degradation

Thermal Information

Parameter	Condition	Value (Typ)	Unit
Thermal Resistance Junction to Case (R _{TH})	T _{CASE} = 50°C, VDD = +28Vdc, IDQ= 360mA, CW signal 40W	0.84	°C /W

Load Pull Performance for Maximum Power (P1dB/P3dB)

Test conditions unless otherwise noted: 25 °C, VDD = +28Vdc, IDQ= 300mA, PW = 40us, DC= 4%

Max Output Power P1dB						
Freq (MHz)	Z _{source} (Ω)	Z _{load} [1] (Ω)	Gain (dB)	P1dB (dBm)	P1dB (W)	Eff (%)
920	0.57-j*1.44	3.80-j*1.42	23.72	48.10	64.57	60.71
1400	0.72-j*2.49	2.89-j*0.40	20.55	47.23	52.84	55.14



HTN7G21S040P(G)

40W, 700 - 2100 MHz LDMOS Amplifier

Product datasheet

1800	0.82-j*2.11	2.46-j*2.50	18.63	47.04	50.58	54.55
2110	0.88-j*4.65	1.87-j*1.85	17.60	46.09	40.64	53.52

[1] Load impedance for optimum P1dB pout

Max Output Power P3dB						
Freq (MHz)	Z_source (Ω)	Z_load [2] (Ω)	Gain (dB)	P3dB (dBm)	P3dB (W)	Eff (%)
920	0.57-j*1.44	3.78-j*1.78	23.39	49.21	83.37	64.86
1400	0.72-j*2.49	2.91-j*0.85	20.12	48.53	71.29	57.91
1800	0.82-j*2.11	2.47-j*2.74	18.31	48.41	69.34	57.52
2110	0.88-j*4.65	1.98-j*2.15	17.07	47.65	58.21	56.24

[2] Load impedance for optimum P3dB pout

Load Pull Performance for Maximum Efficiency (P1dB/P3dB)

Test conditions unless otherwise noted: 25 °C, VDD = +28Vdc, IDQ= 300mA, PW = 40us, DC= 4%

Max Efficiency P1dB						
Freq (MHz)	Z_source (Ω)	Z_load [1] (Ω)	Gain (dB)	P1dB (dBm)	P1dB (W)	Eff (%)
920	0.57-j*1.44	3.66+j*2.21	26.21	46.08	40.55	73.42
1400	0.72-j*2.49	2.17+j*1.73	22.53	45.52	35.65	64.25
1800	0.82-j*2.11	1.09-j*1.00	20.90	45.70	37.15	62.68
2110	0.88-j*4.65	1.79-j*1.17	18.99	45.72	37.33	58.85

[1] Load impedance for optimum P1dB efficiency

Max Efficiency P3dB						
Freq (MHz)	Z_source (Ω)	Z_load [2] (Ω)	Gain (dB)	P3dB (dBm)	P3dB (W)	Eff (%)
920	0.57-j*1.44	3.60+j*2.20	26.22	47.22	52.72	78.59
1400	0.72-j*2.49	2.73+j*1.22	22.14	47.33	54.08	67.26
1800	0.82-j*2.11	1.09-j*1.04	20.80	46.55	45.19	65.97

2110	$0.88-j*4.65$	$1.76-j*1.35$	18.64	46.98	49.89	62.55
------	---------------	---------------	-------	-------	-------	--------------

[2] Load impedance for optimum P3dB efficiency

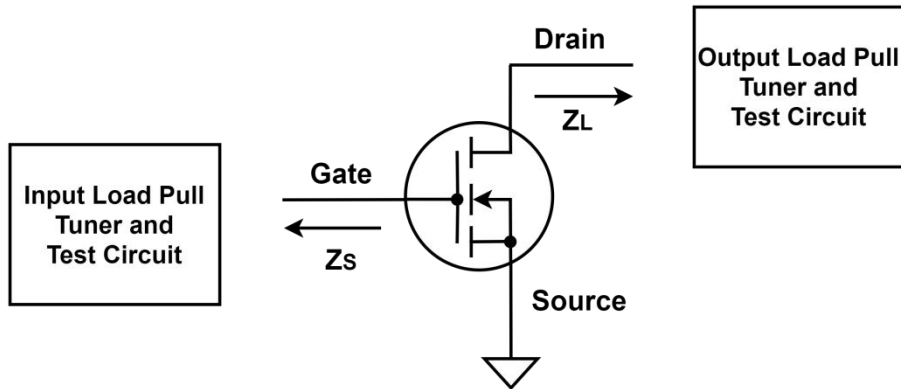

Z_{source} : Measured impedance presented to the input of the device at the package reference plane

Z_{load} : Measured impedance presented to the output of the device at the package reference plane

HTN7G21S040P(G) 920 - 960 MHz Reference Design

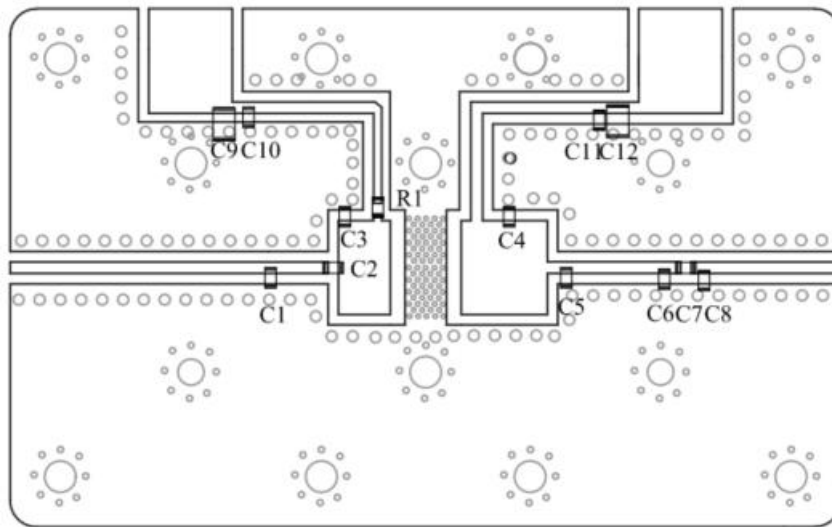

EVB Layout

Bill of Materials (BoM) - HTN7G21S040P(G) 920 - 960 MHz Reference Design

Reference	Value	Description	Manufacturer	P/N
Q1	-	60W, 700 - 2100 MHz LDMOS PA	Watech	HTN7G21S040P(G)
C2,C7,C10, C11	46pF	MLCC	ATC	600S460BT260XT
C3	12pF	MLCC	ATC	600S120BT260XT



HTN7G21S040P(G)

40W, 700 - 2100 MHz LDMOS Amplifier

Product datasheet

C1,C5	10pF	MLCC	ATC	600S100BT260XT
C6	5pF	MLCC	ATC	600S5R0BT260XT
C4	2p5F	MLCC	ATC	600S2R5BT260XT
C8	0p5F	MLCC	ATC	600S0R5BT260XT
C9, C12	10uF	MLCC	Murata	GRM32EC72A106KE05
R1	10Ω	Thick Film Resistor	YAGEO	RC0603FR-0710RL
PCB	RF35 (er = 3.5), 20 mil (0.508 mm), 35 μm (1oz)			

Performance Plots

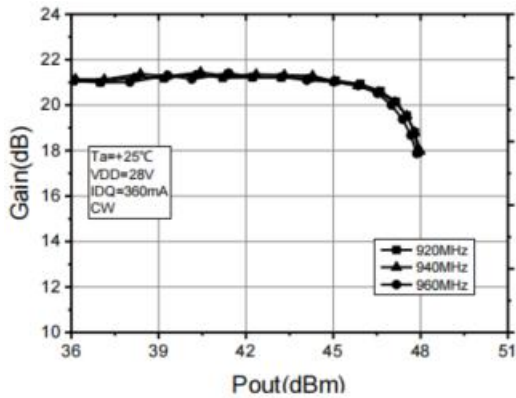

CW, Gain vs Pin

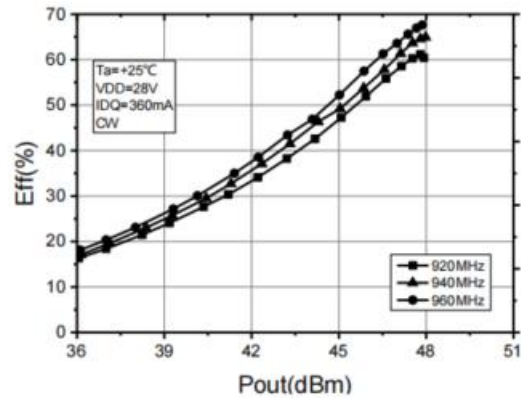

CW, Efficiency vs Pout

Test conditions unless otherwise noted: 25 °C, VDD = +28Vdc, IDQ=360mA test on WATECH Application Board

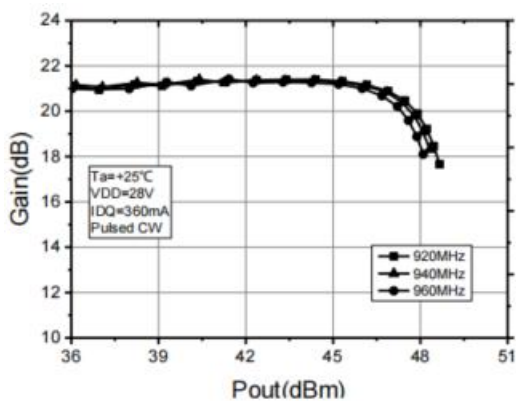

Pulsed CW, Pout vs Pin

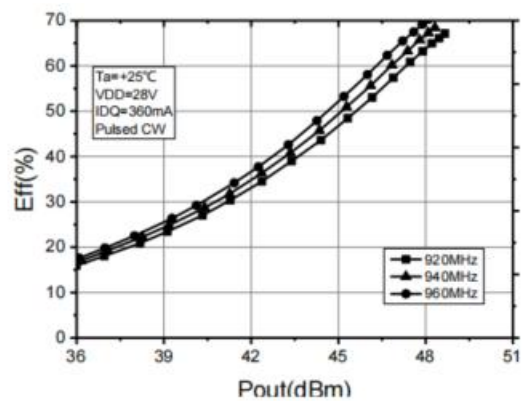

Pulsed CW, Efficiency vs Pout

Test conditions unless otherwise noted: 25 °C, VDD = +28Vdc, IDQ=360mA, PW = 100us, DC= 10% test on WATECH Application Board



HTN7G21S040P(G)

40W, 700 - 2100 MHz LDMOS Amplifier

Product datasheet

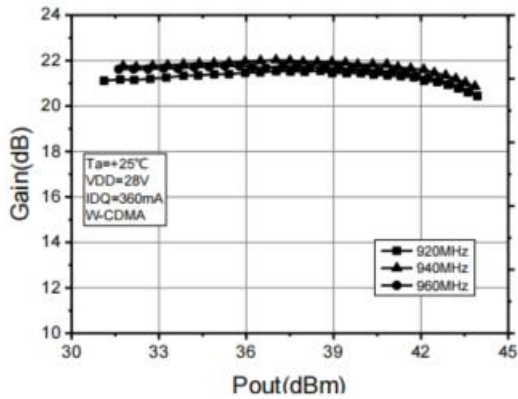

WCDMA, Gain vs Pout

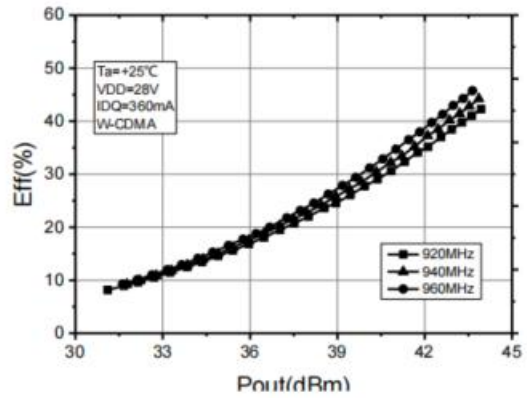

WCDMA, Efficiency vs Pout

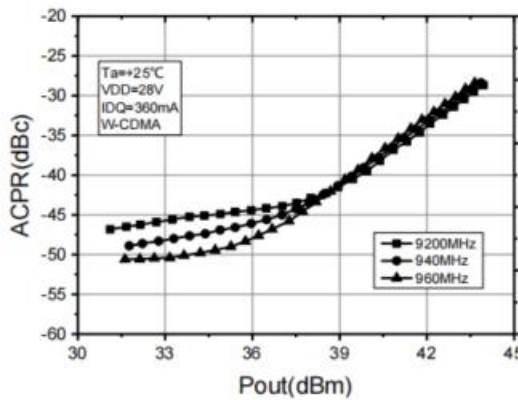

WCDMA, ACPR_5MHz, ACPR_10MHz vs Pout

Test conditions unless otherwise noted: 25 °C, VDD = +28Vdc, IDQ=360mA, 1C-WCDMA 5MHz Signal, 9.9 dB PAR @ 0.01% CCDF test on WATECH Application Board

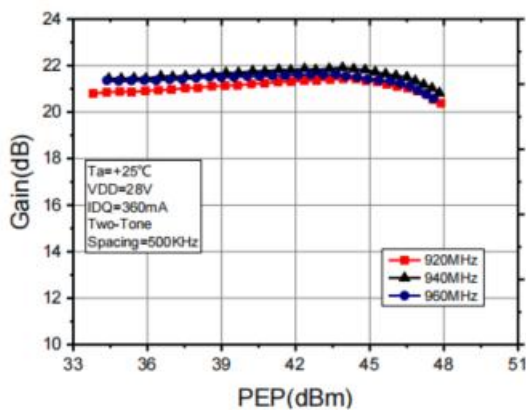

Two Tones Gain vs Pout (PEP) @Freq's

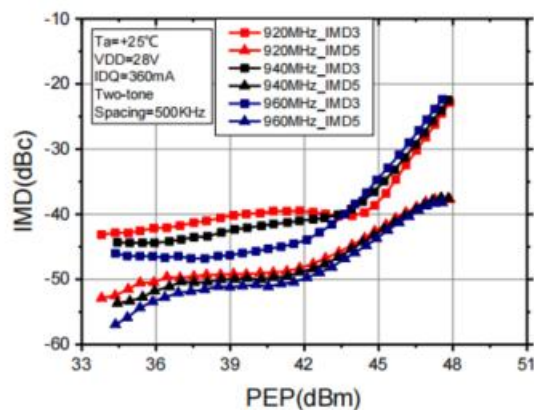

Two Tones IMD vs Pout (PEP) @Freq's

Test conditions unless otherwise noted: 25 °C, VDD = +28Vdc, IDQ=360mA, Two tone Test, Carrier Spacing @500KHz test on WATECH Application Board

HTN7G21S040P(G) 1800 - 1880 MHz Reference Design

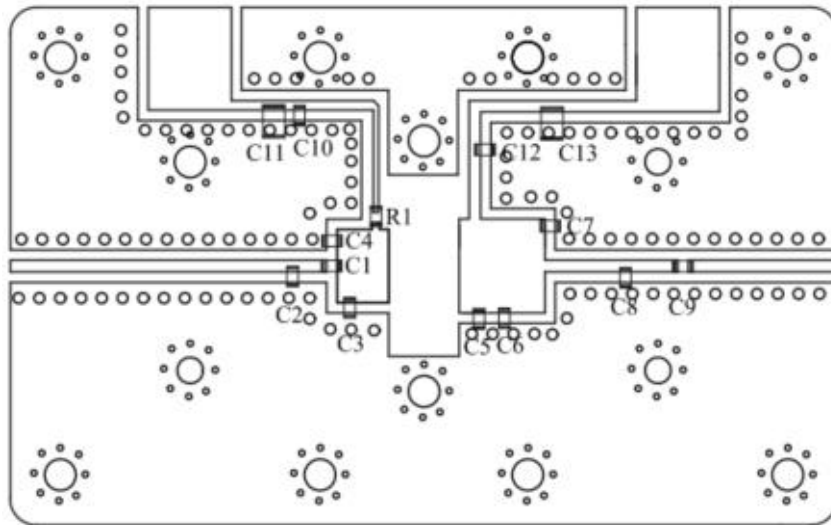

EVB Layout

Bill of Materials (BoM) - HTN7G21S040P(G) 1800 - 1880 MHz Reference Design

Reference	Value	Description	Manufacturer	P/N
Q1	-	60W, 700 - 2100 MHz LDMOS PA	Watech	HTN7G21S040P(G)
C1, C9, C10, C12	10pF	MLCC	ATC	600S100BT260XT
C2, C4	2pF	MLCC	ATC	600S2R0BT260XT
C3, C5, C6, C7	3p3F	MLCC	ATC	600S3R3BT260XT
C8	1pF	MLCC	ATC	600S1R0BT260XT
C11, C13	10uF	MLCC	Murata	GRM32EC72A106KE05
R1	10Ω	Thick Film Resistor	YAGEO	RC0603FR-0710RL
PCB	Rogers RO4350B (er = 3.6), 20 mil (0.508 mm), 35 μm (1oz)			

Performance Plots

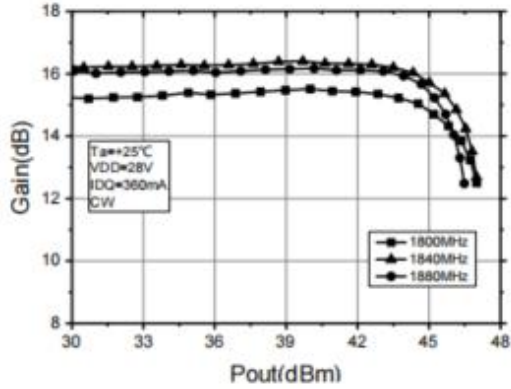

CW, Gain vs Pin

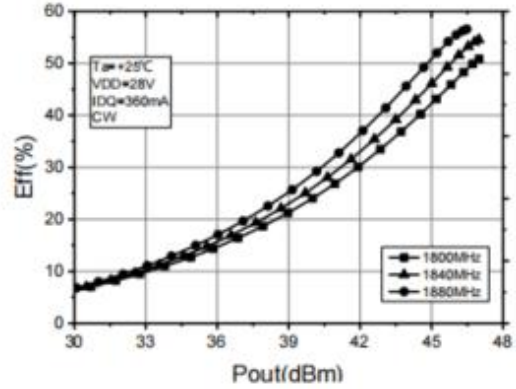

CW, Efficiency vs Pout

Test conditions unless otherwise noted: 25 °C, VDD = +28Vdc, IDQ=360mA test on WATECH Application Board

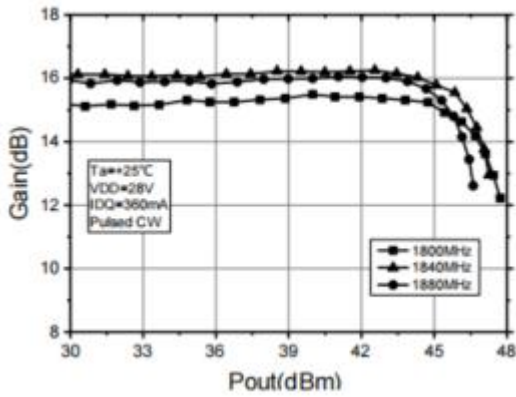

Pulsed CW, Pout vs Pin

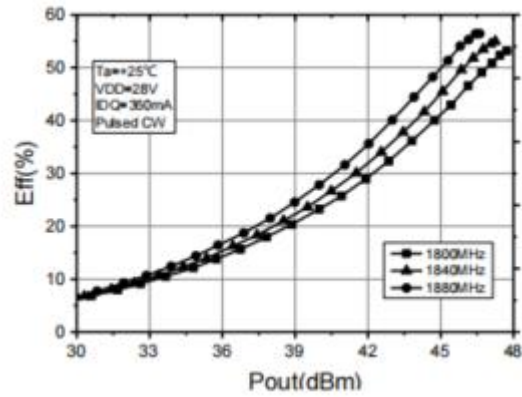

Pulsed CW, Efficiency vs Pout

Test conditions unless otherwise noted: 25 °C, VDD = +28Vdc, IDQ=360mA, PW = 100us, DC= 10% test on WATECH Application Board

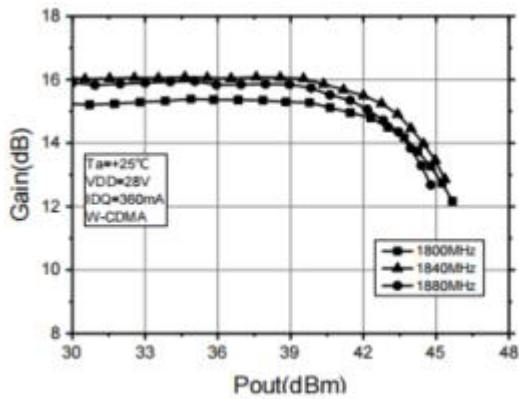

WCDMA, Gain vs Pout

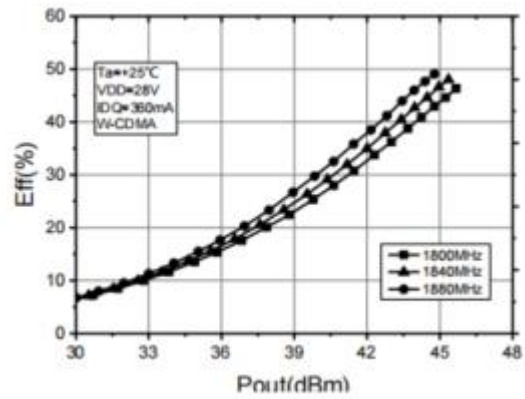

WCDMA, Efficiency vs Pout

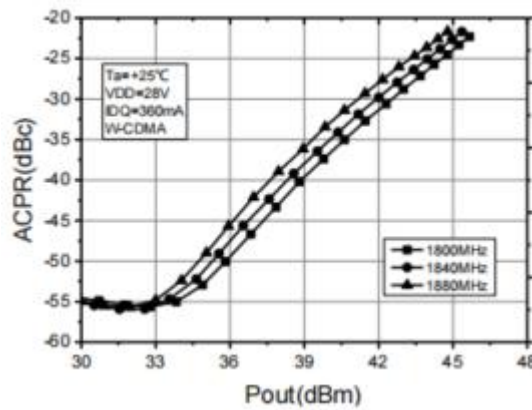

WCDMA, ACPR_5MHz, ACPR_10MHz vs Pout

Test conditions unless otherwise noted: 25 °C, VDD = +28Vdc, IDQ=360mA, 1C-WCDMA 5MHz Signal, 9.9 dB PAR @ 0.01% CCDF test on WATECH Application Board

Package Marking and Dimensions

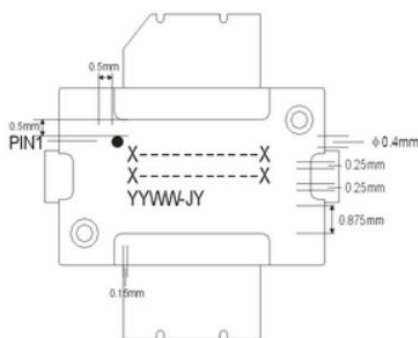

- Line1 (fixed): Device name in work order
 - Line2 (unfixed): Mark Lot Number in work order (Sample: E596-20140001)
 - Line3 (unfixed): Date Code + JY
- This Marking SPEC only stipulates the content of Marking. For marking requirements such as font and size, please refer to the latest version of "Watech Product Printing Specification"

Marking
TO-270

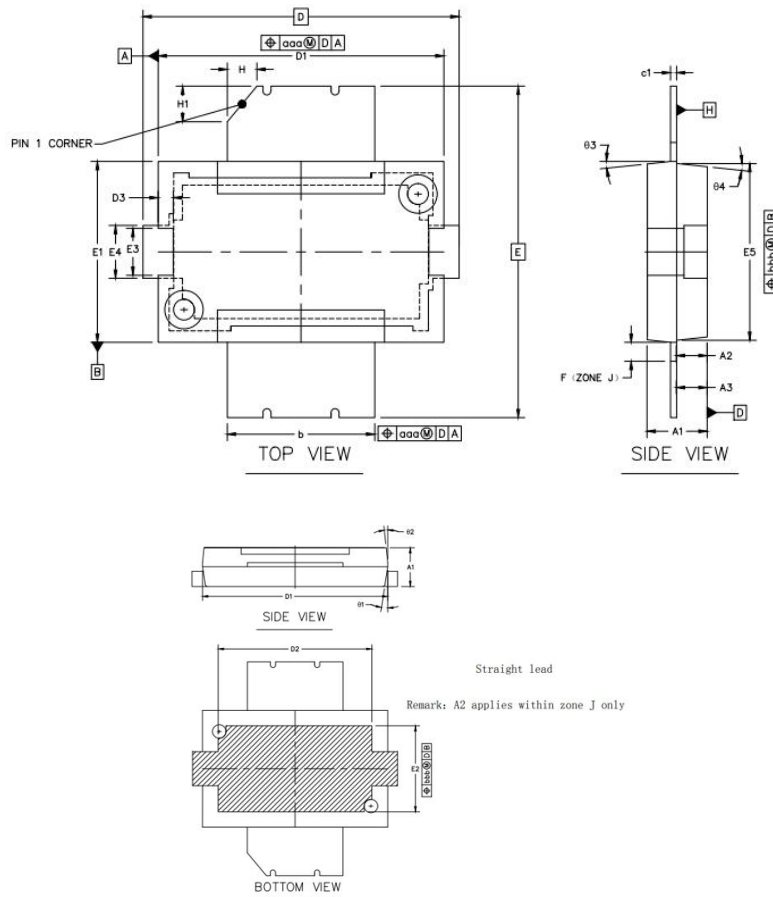

		SYMBOL	MIN	NOM	MAX
TOTAL THICKNESS		A1	1.98	2.03	2.08
MOLD THICKNESS		A2	1.02	1.045	1.07
		A3	0.99	1.04	1.09
L/F THICKNESS		C1	0.203 REF		
BODY SIZE	X	D	10.57	10.67	10.77
	Y	E	11.08	11.18	11.28
LEAD SIZE	X	D2	7.37 MIN		
	Y	E2	3.81 MIN		
MOLD LENGTH		D1	9.6	9.65	9.7
LEAD LENGTH		D3	0.41	0.51	0.61
MOLD WIDTH		E1	6.05	6.1	6.15
WIDTH		E3	1.48	1.58	1.68
		E4	1.68	1.78	1.88
		E5	5.91	5.96	6.01
ZONE WIDTH		F	0.64 BSC		
LEAD WIDTH		b	4.9	4.98	5.06
PACKAGE EDGE TOLERANCE		aaa	0.1		
LEAD OFFSET		bbb	0.2		
TAPER ANGLE		θ1	7°	9°	11°
		θ2	4°	6°	8°
		θ3	4°	6°	8°
		θ4	4°	6°	8°
PIN1 SIZE		H	1 REF		
		H1	1.2 REF		

Package Dimensions

TO-270-A

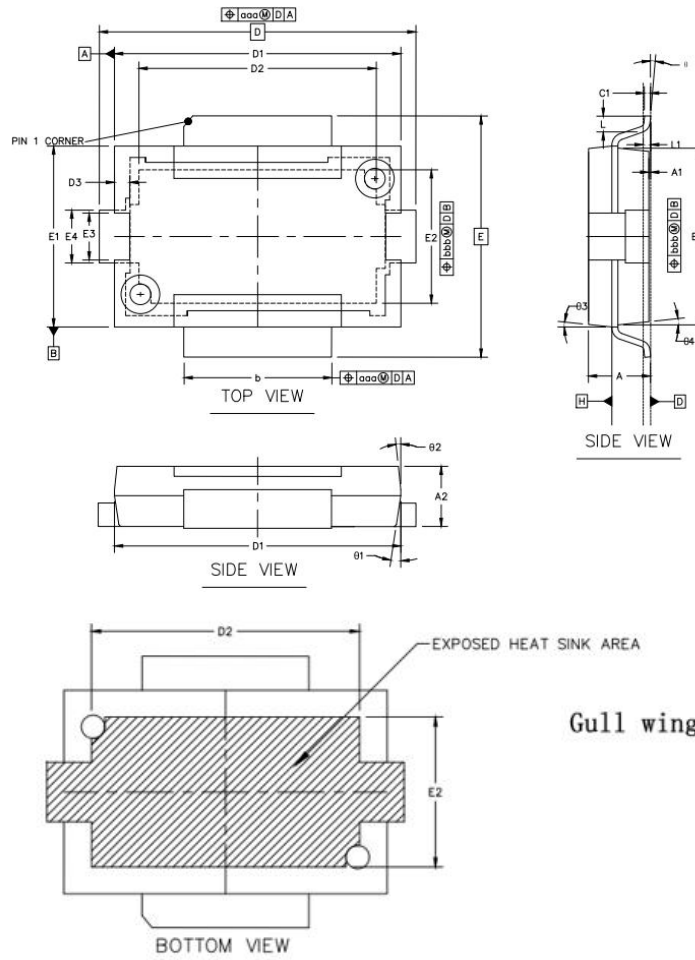

Gull wing

		SYMBOL	MIN	NOM	MAX
TOTAL THICKNESS		A	1.96	2.095	2.23
MOLD THICKNESS		A1	0.03	0.065	0.1
		A2	1.98	2.03	2.08
L/F THICKNESS		C1	0.18	0.203	0.23
BODY SIZE	X	D	10.57	10.67	10.77
	Y	E	8.03	8.13	8.23
MOUNTING HOLE SIZE	X	D2	7.37 MIN		
	Y	E2	3.81 MIN		
MOLD LENGTH		D1	9.6	9.65	9.7
LENGTH		D3	0.41	0.51	0.61
MOLD WIDTH		E1	6.05	6.1	6.15
WIDTH		E3	1.48	1.58	1.68
		E4	1.68	1.78	1.88
		E5	5.91	5.96	6.01
LEAD WIDTH		b	4.9	4.98	5.06
PACKAGE EDGE TOLERANCE		aaa	0.1		
LEAD OFFSET		bbb	0.2		
TAPER ANGLE		θ 1	7°	9°	11°
		θ 2	4°	6°	8°
		θ	2°	5°	8°
		θ 3	4°	6°	8°
		θ 4	4°	6°	8°
		L	0.46	0.535	0.61
		L1	0.25 REF		

Package Dimensions

Tape and Reel Information

Package Type	Reel Size(inch)	Qty/Reel(pcs)	Qty/Box(pcs)	Qty/Carton(pcs)
TO270 (Straight)	13inch	1500	1500	7500

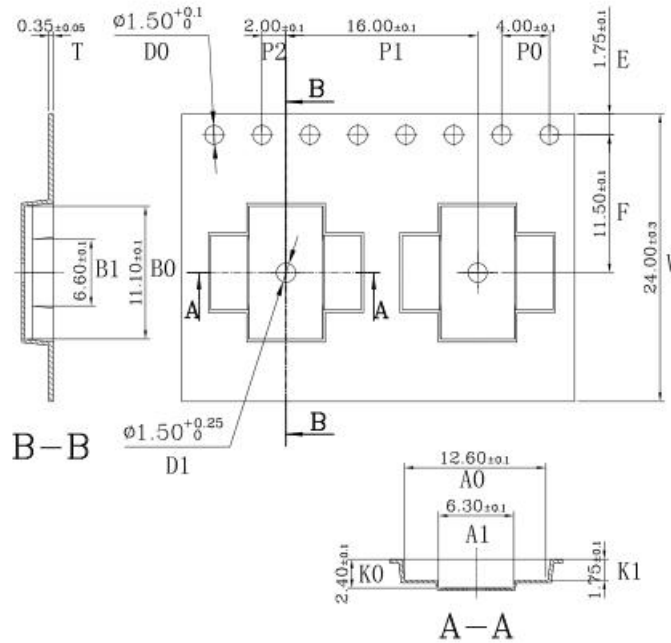

Package Type	Reel Size(inch)	Qty/Reel(pcs)	Qty/Box(pcs)	Qty/Carton(pcs)
TO270 (Gull Wing)	13inch	1500	1500	7500

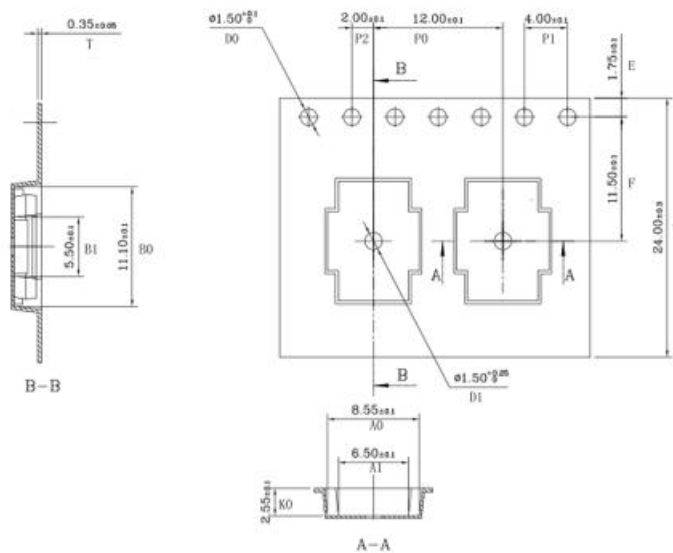

Tape & Reel Packaging Descriptions

Handling Precautions

Parameter	Grade
Moisture Sensitivity Level MSL	3

Parameter	Rating	Standard	
ESD – Human Body Model (HBM)	Class 1B	JESD22-A114	
ESD – Human Body Model (MM)	Class A	EIA/JESD22-A115	
ESD – Charged Device Model (CDM)	Class III	JESD22-C101	

RoHS Compliance

This product is compliant with the 2011/65/EU RoHS directive (Restrictions on the Use of Certain Hazardous Substances in Electrical and Electronic Equipment), as amended by Directive 2015/863/EU.

Datasheet Status

Document status	Product status	Definition
Objective Datasheet	Design simulation	Product objective specification
Preliminary Datasheet	Customer sample	Engineering samples and first test results
Product Datasheet	Mass production	Final product specification

Abbreviations

Acronym	Definition
LDMOS	Laterally-Diffused Metal-Oxide Semiconductor
CW	Continuous Waveform

Revision history

Document ID	Datasheet Status	Release Date	Revision Version
Rev 2.2	Product	March 2023	New format based on English version datasheet
Rev 2.3	Product	April 2024	Update TBD information



HTN7G21S040P(G) 40W, 700 - 2100 MHz LDMOS Amplifier

Product datasheet

Contact Information

For the latest specifications, additional product information, worldwide sales and distribution locations and information about WATECH:

- Web: www.watechelectronics.com
- Email: MKT@huatai-elec.com

For technical questions and application information:

- Email: MKT@huatai-elec.com

Important Notice

Information in this document is believed to be accurate and reliable. However, WATECH does not give any representations or warranties, expressed or implied, as to the accuracy or completeness of such information and shall have no liability for the consequences of use of such information.

“Typical” parameters are the average values expected by WATECH in large quantities and are provided for information purposes only. All information and specifications contained herein are subject to change without notice and customers should obtain and verify the latest relevant information before placing orders for WATECH products.

The information contained herein or any use of such information does not grant, explicitly or implicitly, to any party any patent rights, licenses, or any other intellectual property rights, whether with regard to such information itself or anything described by such information.

Applications that are described herein for any of these products are for illustrative purposes only. WATECH makes no representation or warranty that such applications will be suitable for the specified use without further testing or modification. Customers are responsible for the design and operation of their applications and products using WATECH products, and WATECH accepts no liability for any assistance with applications or customer product design. It is customer's sole responsibility to determine whether the WATECH product is suitable and fit for the customer's applications and products planned, as well as for the planned application and use of customer's third-party customer(s). Customers should provide appropriate design and operating safeguards to minimize the risks associated with their applications and products.

WATECH products are not designed, authorized or warranted to be suitable for use in life support, life-critical or safety- critical systems or equipment, nor in applications where failure or malfunction of a WATECH product can reasonably be expected to result in personal injury, death or severe property or environmental damage. This document as well as the item(s) described herein may be subject to export control regulations. Export might require a prior authorization from competent authorities.